

GP1A50HR/GP1A51HR GP1A52HR/GP1A53HR

OPIC Photointerrupter

■ Features

1. High sensing accuracy (Slit width : 0.5mm)
2. LSTTL and TTL compatible output
3. Both-sides mounting type : **GP1A50HR** (Gap: 3mm)
 Either-side mounting type : **GP1A51HR** (Gap: 3mm)
 PWB mounting type : **GP1A52HR** (Gap: 3mm)
GP1A53HR (Gap: 5mm)

■ Applications

1. OA equipment, such as printers, facsimiles, etc.
2. VCRs

**OPIC™ (Optical IC) is a trademark of the SHARP Corporation.
 An OPIC consists of a light-detecting element and signal-processing circuit integrated onto a single chip.

■ Outline Dimensions

(Unit : mm)

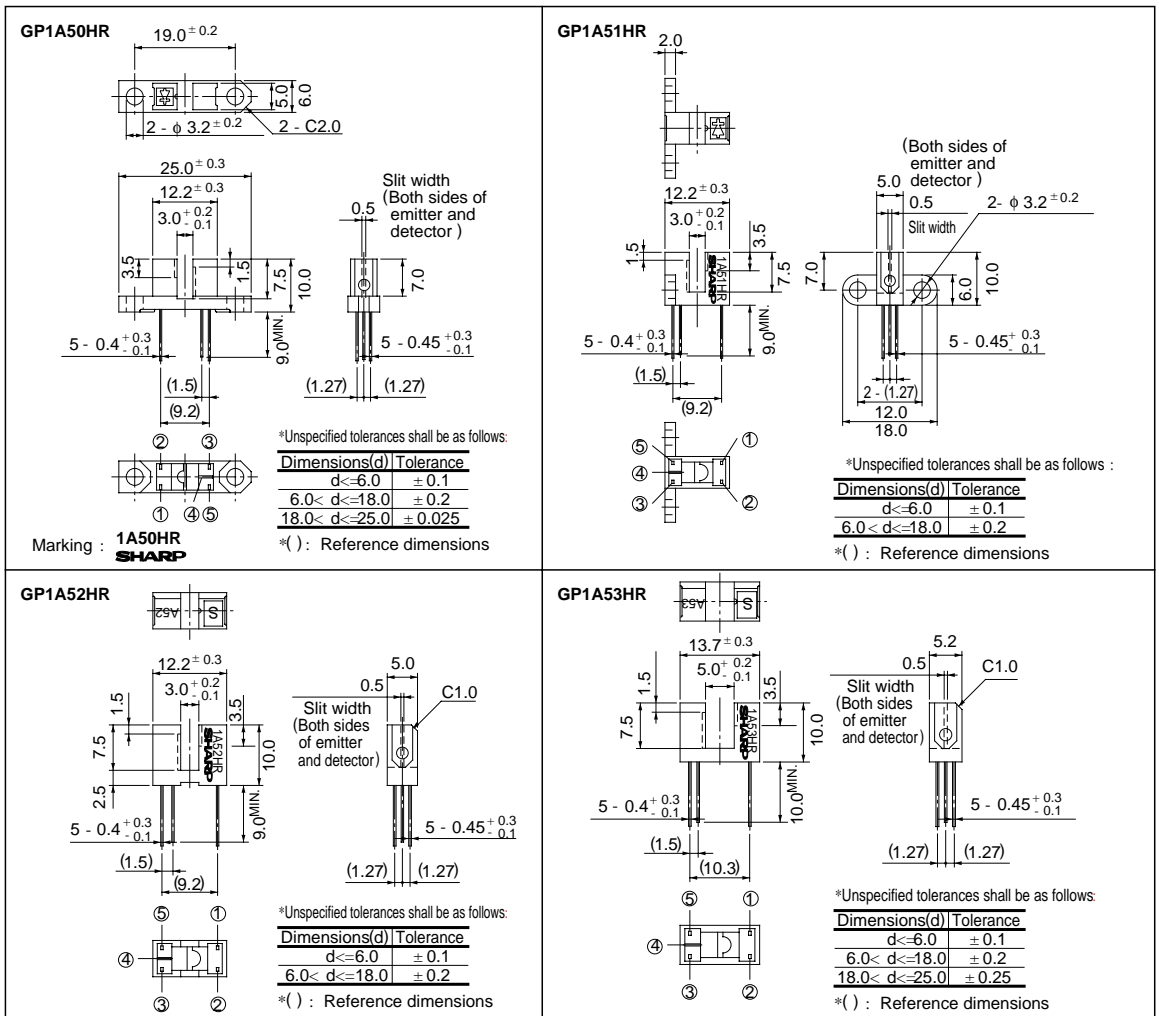

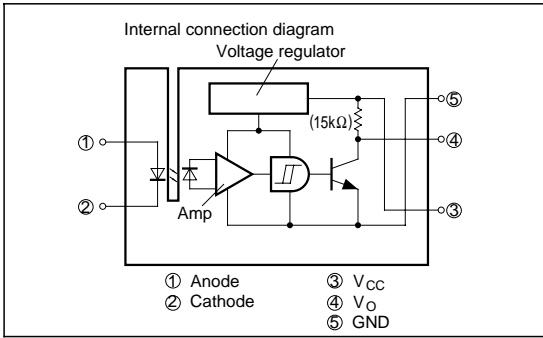

Absolute Maximum Ratings

(T_a = 25°C)

Parameter		Symbol	Rating	Unit
Input	Forward current	I _F	50	mA
	*1 Peak forward current	I _{FM}	1	A
	Reverse voltage	V _R	6	V
	Power dissipation	P	75	mW
Output	Supply voltage	V _{CC}	- 0.5 to + 17	V
	Output current	I _O	50	mA
	Power dissipation	P _O	250	mW
Operating temperature		T _{opr}	- 25 to + 85	°C
Storage temperature		T _{stg}	- 40 to + 100	°C
*2 Soldering temperature		T _{sol}	260	°C

*1 Pulse width ≤ 100 μs, Duty ratio = 0.01

*2 For 5 seconds

Electro-optical Characteristics

(T_a = 25°C)

Parameter		Symbol	Conditions	MIN.	TYP.	MAX.	Unit	
Input	Forward voltage	GP1A50HR/GP1A51HR GP1A52HR	V _F I _F = 5mA	-	1.1	1.4	V	
		GP1A53HR	V _F I _F = 8mA	-	1.14	1.4	V	
	Reverse current	I _R	V _R = 3V	-	-	10.0	μA	
Output	Operating supply voltage	V _{CC}		4.5	-	17.0	V	
	Low level output voltage	V _{OL}	V _{CC} = 5V, I _F = 0, I _{OL} = 16mA	-	0.15	0.4	V	
	High level output voltage	V _{OH}	V _{CC} = 5V, *5 I _F = 5mA	4.9	-	-	V	
	Low level supply current	I _{CCL}	V _{CC} = 5V, I _F = 0	-	1.7	3.8	mA	
	High level supply current	I _{CCH}	V _{CC} = 5V, *5 I _F = 5mA	-	0.7	2.2	mA	
Transfer characteristics	*3 "Low→High" threshold input current	GP1A50HR/GP1A51HR GP1A52HR	I _{FLH} V _{CC} = 5V	-	1.0	5.0	mA	
		GP1A53HR	I _{FLH} V _{CC} = 5V	-	1.5	8.0	mA	
	*4 Hysteresis	I _{FHL} / I _{FLH}	V _{CC} = 5V	0.55	0.75	0.95		
	Response time	"Low→High" propagation delay time	t _{PLH}	V _{CC} = 5V, *5 I _F = 5mA R _L = 280Ω	-	3.0	9.0	μs
		"High→Low" propagation delay time	t _{PHL}		-	5.0	15.0	
Rise time		t _r	-		0.1	0.5		
	Fall time	t _f		-	0.05	0.5		

*3 I_{FLH} represents forward current when output changes from low to high.*4 I_{FHL} represents forward current when output changes from high to low. Hysteresis stands for I_{FHL} / I_{FLH}.*5 GP1A53HR Condition of V_{OH}, I_{CCH}, Response time; I_F = 8mA

■ Recommended Operating Conditions

Parameter	Symbol	Operating temp.	MIN.	MAX.	Unit
Low level output current	I_{OL}	$T_a = 0 \text{ to } +70^\circ\text{C}$	-	16.0	mA
Forward current	I_F		10.0	20.0	mA

Fig. 1 Forward Current vs. Ambient Temperature

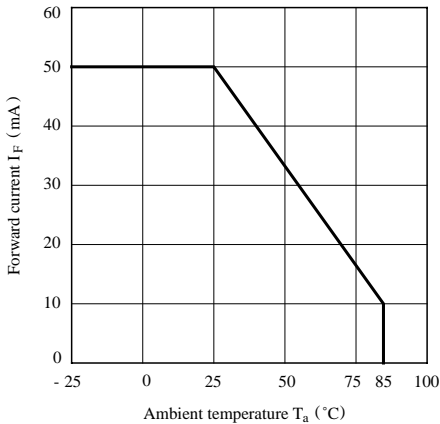

Fig. 2 Output Power Dissipation vs. Ambient Temperature

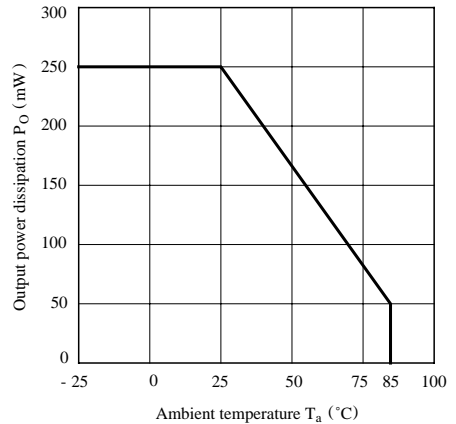

Fig. 3 Low Level Output Current vs. Ambient Temperature

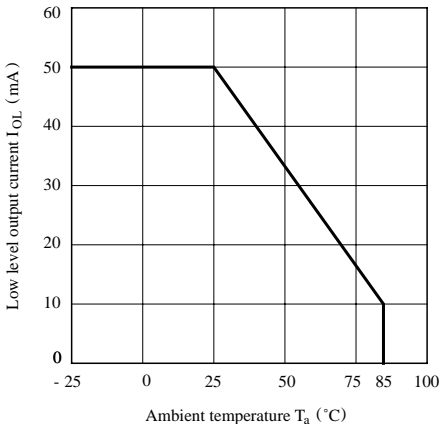

Fig. 4 Forward Current vs. Forward Voltage

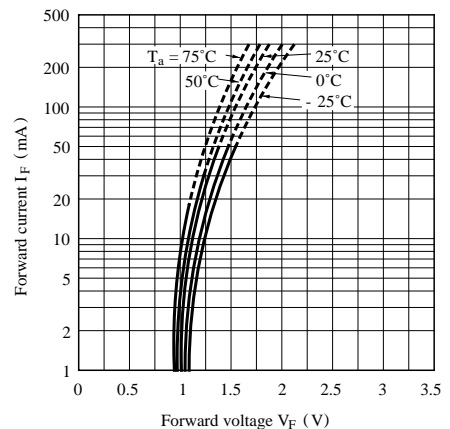

Fig. 5 Relative Threshold Input Current vs. Supply Voltage

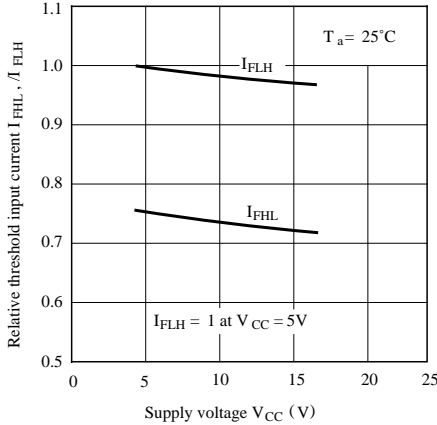

Fig. 6 Relative Threshold Input Current vs. Ambient Temperature

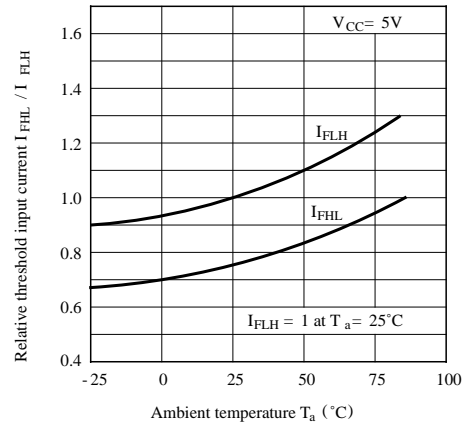

Fig. 7 Low Level Output Voltage vs. Low Level Output Current

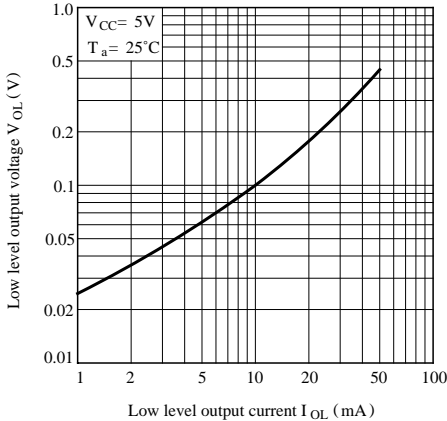

Fig. 8 Low Level Output Voltage vs. Ambient Temperature

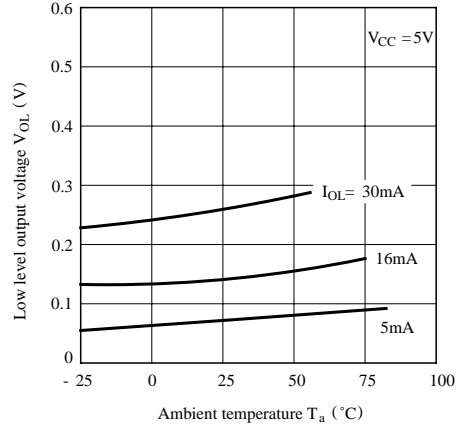

Fig. 9 Supply Current vs. Ambient Temperature

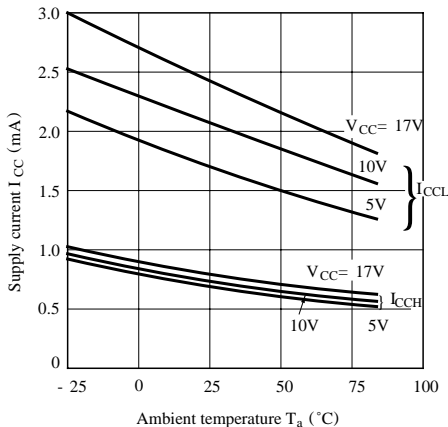

Fig.10-a Propagation Delay Time vs. Forward Current (GP1A50HR/GP1A51HR/GP1A52HR)

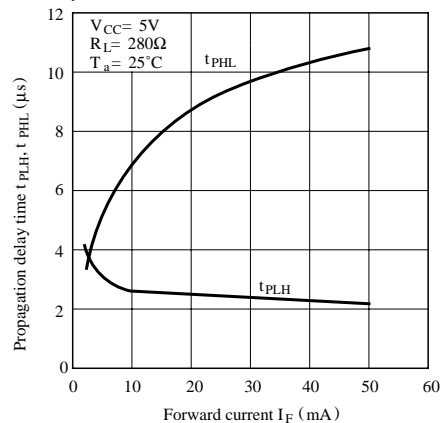

Fig.10-b Propagation Delay Time vs. Forward Current (GP1A53HR)

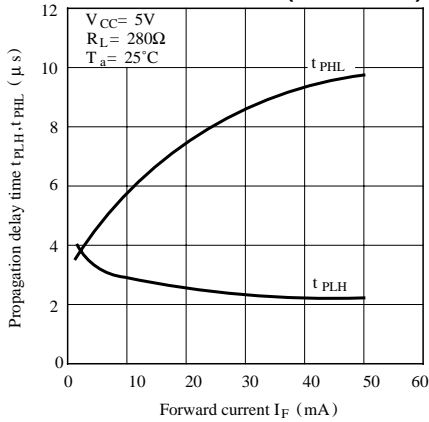
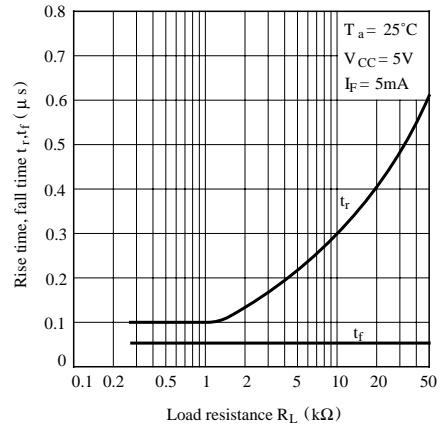
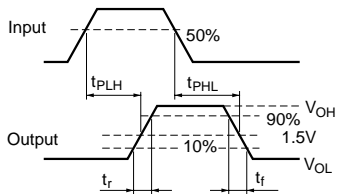
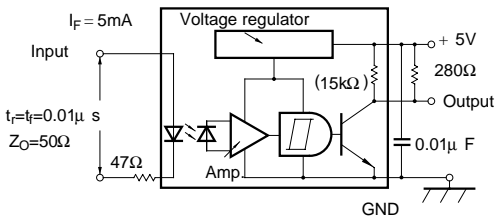

Fig.12 Rise Time, Fall Time vs. Load Resistance



Test Circuit for Response Time



■ Precautions for Use

- (1) In order to stabilize power supply line, connect a by-pass capacitor of more than $0.01\mu F$ between V_{CC} and GND near the device.
- (2) In case of cleaning, use only the following type of cleaning solvent.
Ethyl alcohol, Methyl alcohol, Isopropyl alcohol
- (3) As for other general cautions refer to the chapter "Precautions for Use".

NOTICE

- The circuit application examples in this publication are provided to explain representative applications of SHARP devices and are not intended to guarantee any circuit design or license any intellectual property rights. SHARP takes no responsibility for any problems related to any intellectual property right of a third party resulting from the use of SHARP's devices.
- Contact SHARP in order to obtain the latest device specification sheets before using any SHARP device. SHARP reserves the right to make changes in the specifications, characteristics, data, materials, structure, and other contents described herein at any time without notice in order to improve design or reliability. Manufacturing locations are also subject to change without notice.
- Observe the following points when using any devices in this publication. SHARP takes no responsibility for damage caused by improper use of the devices which does not meet the conditions and absolute maximum ratings to be used specified in the relevant specification sheet nor meet the following conditions:
 - (i) The devices in this publication are designed for use in general electronic equipment designs such as:
 - Personal computers
 - Office automation equipment
 - Telecommunication equipment [terminal]
 - Test and measurement equipment
 - Industrial control
 - Audio visual equipment
 - Consumer electronics
 - (ii) Measures such as fail-safe function and redundant design should be taken to ensure reliability and safety when SHARP devices are used for or in connection with equipment that requires higher reliability such as:
 - Transportation control and safety equipment (i.e., aircraft, trains, automobiles, etc.)
 - Traffic signals
 - Gas leakage sensor breakers
 - Alarm equipment
 - Various safety devices, etc.
 - (iii) SHARP devices shall not be used for or in connection with equipment that requires an extremely high level of reliability and safety such as:
 - Space applications
 - Telecommunication equipment [trunk lines]
 - Nuclear power control equipment
 - Medical and other life support equipment (e.g., scuba).
- Contact a SHARP representative in advance when intending to use SHARP devices for any "specific" applications other than those recommended by SHARP or when it is unclear which category mentioned above controls the intended use.
- If the SHARP devices listed in this publication fall within the scope of strategic products described in the Foreign Exchange and Foreign Trade Control Law of Japan, it is necessary to obtain approval to export such SHARP devices.
- This publication is the proprietary product of SHARP and is copyrighted, with all rights reserved. Under the copyright laws, no part of this publication may be reproduced or transmitted in any form or by any means, electronic or mechanical, for any purpose, in whole or in part, without the express written permission of SHARP. Express written permission is also required before any use of this publication may be made by a third party.
- Contact and consult with a SHARP representative if there are any questions about the contents of this publication.